



Creating Security Solutions
With Care.

GT490X Control Panel

Quick Start Instructions

Download the complete GT490X Engineer's Ref. Guide at
www.riscogroup.co.uk

RISCO Group UK Ltd

Tel: 0161 655 5500 Fax: 0161 655 5501
Int Tel: +44 161 655 5500 Fax: +44 161 655 5501

Internet: www.riscogroup.co.uk

e-mail: sales@riscogroup.co.uk

Technical Support Tel: 0161 655 5600

Technical Support Fax: 0161 655 5610

(Mon - Fri 08:30-1730)

*This Quick Start Guide gives brief installation information for the **GT490X** Control Panel. RISCO Group UK Ltd reserve the right to amend the software and features without prior notice.*



INVESTOR IN PEOPLE



IMPORTANT!

Input: GT490X	AC230V +/-10% ~50Hz 125mA Max. 35W Max
Nominal Temp Range:	0 - 50°C
Humidity	70% non condensing
	GT490X Metal For Indoor Use Only

This equipment is intended only for use as a Security Alarm Control Panel. Adequate ventilation away from heat and humidity must be provided. The unit must be fixed securely to a non-flammable surface using suitable fixings.

All mains wiring must conform to the relevant current IEEE wiring regulations (or appropriate international regulatory standards). See Mains Supply Connection section within this manual for more detailed instructions.

All wiring must be protected from sharp or jagged edges.

All Low voltage (alarm) wiring must be to the appropriate international regulatory standards and comply to good wiring practice and should be routed away from the mains cables.

Replacement fuses should be of the same type and rating conforming to IEC 127.

The GT490X Control Panel is fitted with resettable fuses. The areas protected are Battery, Aux and Keypad. In the event of a fuse tripping or an input/ output not working, remove the source of the load and check wiring for shorts. Check any added devices for full functionality before any reconnection.

The maximum current draw from the unit for all output combinations **must not exceed the rated output.**

The unit is intended for use with a suitable re-chargeable lead acid battery permanently connected to the appropriate terminals. All documentation and manuals must be thoroughly read by suitably qualified installation personnel prior to installation.



Important Safety Information. Hazardous Voltages Inside, The unit has no user serviceable parts inside. No User Access. Internal access should only be by suitably qualified personnel.

GT490X Metal

The unit MUST be Earthed. It is the responsibility of the installation engineer to ensure that the earth connection to the unit lid is good on completion of the installation or after service.

Introduction

The GT490X Control Panel is a microprocessor based unit that has been designed to be suitable for all types of domestic and commercial installations. All zones are fully programmable by the engineer.

On power up / reset, the Control Panel can be set to the old BS or EN2 (Grade 2) operating standards. Selection for PD6662 2004 /PD6662 2010 standard can also be set at this point. (See page 10 for further details).

Upon completion of the installation the engineer may, if required, re-program several factory set options so as to tailor the Control Panel to suit the requirements of the system.

It should be noted that if the engineer code has been locked into the system it may only be changed by using the code again (default to factory settings will have no effect).

We recommend that the Installation manual and the user manual are read and fully understood before any installation of the system is carried out. This Quick Start Guide is intended for use by engineers who have experience in installing GT security equipment. Greater detail is given in the GT490X Manual available from our website.

Planning the Control Panel Location

Consideration in locating the fixing position of the Control Panel should be given to:

Access for the routing of cables for the system from detection devices, sounders (internal and external), remote keypads, mains, etc.

The position of the underside retaining screw.

The fixing of a 3 amp unswitched fused spur.

When fitting the RKP(s) consideration should be given to:
Operation of the keypad.

Readability of the display.

The Panel should be fixed to the wall using appropriate wall plugs and No.8 screws at least 30mm long. Do not tighten the screws at this stage, wait until all your wiring is in place.

⚠ Mains Supply Connection - WARNING: Electricity can KILL

Before connecting the control panel ALWAYS disconnect the supply at the consumer unit. A 230V a.c supply should be taken directly from the consumer unit. In order to comply with the relevant current wiring regulations this should be via a 3 Amp fused spur with disconnection facility. This must be carried out by a suitably qualified electrician. If you are in any doubt please contact your local electricity company for advice.

This control panel MUST be Earthed.

Output Terminal Descriptions

Speaker Terminals

This pair of terminals provide connection for:-

System Speaker(s)

Optional 16/32 Ohm Panel Speaker

A speaker is supplied in each keypad. If any additional speakers are fitted they should present a minimum impedance of **16 Ohm**.

PGM 1, 2 & 3 Terminals

The PGM1 & 2 terminals are an open collector output held at 12V through an integral 1k resistor. Max current sink into PGM 1 & 2 terminals is **50mA**. The terminals are programmable for various uses if required.

Note: PGM3 terminal is the strobe- terminal and is only available as a programmable option if the Strobe terminal is not used for the External Sounder e.g. when NovActive sounders are used.
Max current for switch is **1A**.

Power Supply Rating

GT490X Max. O/P current - **0.8A plus 0.123mA for batt. charge.**

Sounders, detectors and other auxiliary items, including the control panel and keypad(s), should be included when calculating current drawn by the system. Any damage caused through overloading the control panel supply will not be covered by the warranty. We recommend that additional power supplies are used to supply detectors on long cable runs.

AUX 12V Terminals

This pair of terminals supply the + and - supply for the detectors. **1A** available from these terminals.

Strobe Terminals

This pair of terminals are the output for the Strobe. The negative terminal is switched during an alarm period. Max current for switch is **1A**.

Bell Terminals

This pair of terminals are the output for the Bell or external sounder. The negative terminal is switched during an alarm period. Max sink current for switch is **1A**.

Keypads

The + and - terminals supply power to the keypads.

Remote Keypads

Up to four remote keypads may be fitted to the GT490X control panel. Each Keypad offers a 32 character backlit LCD.

A four core connection will be required between the control panel and remote keypad(s), keypads may be in a 'daisy chain' or 'star' format.

Note: 680 Ohm resistor must be fitted to ONE RKP. If the RKPs are wired in daisy chain format this should be the last RKP in the line.

Note: Each keypad must be programmed onto the system in order for it to be recognised by the system.

Note: Depending on the variant of keypad fitted external G-Tag Proximity Reader(s) may be fitted to each Remote Keypad.

Fig.1 RKP Connections

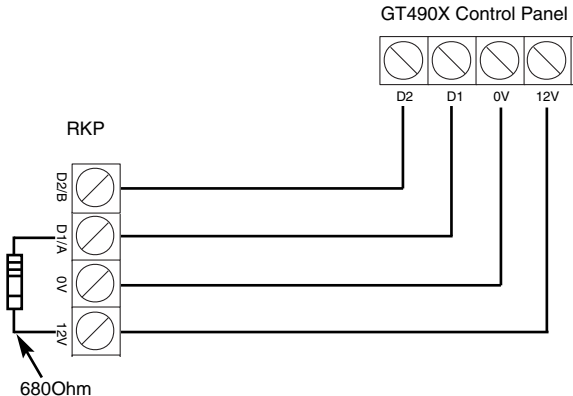

Digi Modem - The GT490X control panel feature an onboard Digi modem. The Digi provides all the features of an eight channel communicator whilst the Modem provides facilities for Gardtec Remote Upload/Download software package.

Vo-Comm - (If fitted) Is a method of transmitting signals to a standard land-line or mobile telephone, giving information regarding the status of your security system. If **On** is selected, the Vo-Comm menu will now appear in the USER mode. Please refer to GT490X User Guide for further programming information.

Fig.2 Telephone Connections

Standard Telephone Connection

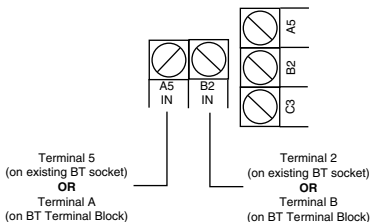

Serial Telephone Connection (depending on model)

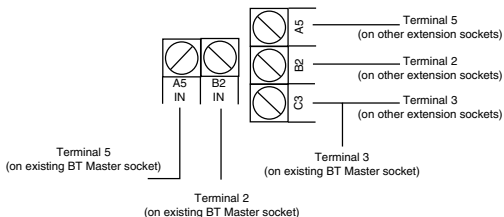
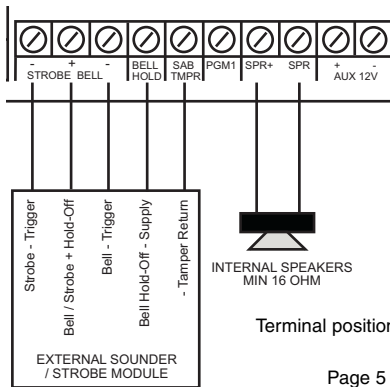

Fig.3 Control Panel Output Connections



Terminal positions may differ.

Fig.4 Typical Novagard 2G/4G Connections

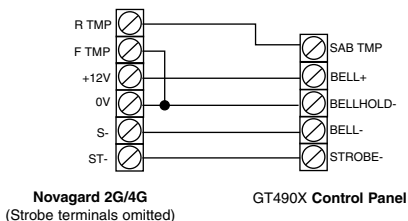

Fig.5 Control Panel Input (Zone) Connections

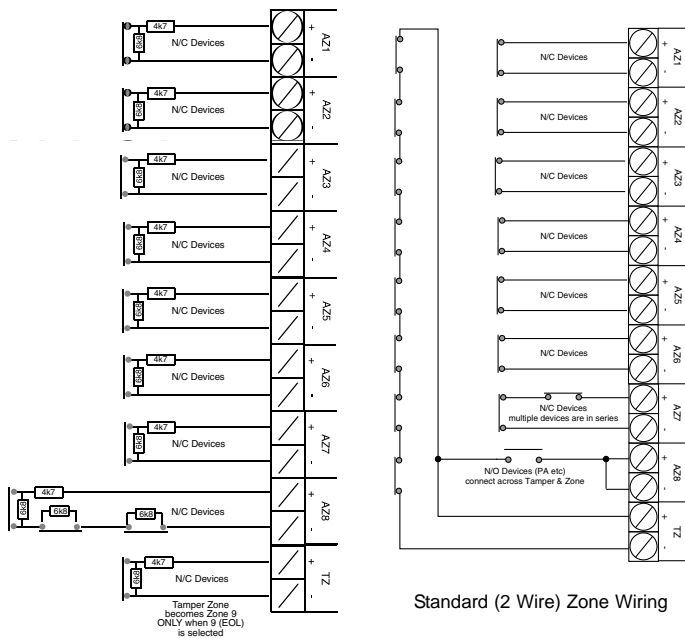
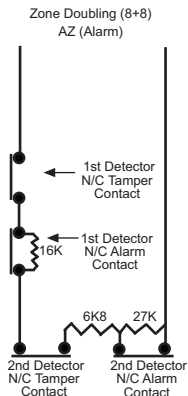

Fig.6 Zone Doubling Mode (8+8)



Zone Doubling

Detector on Zone 1 will be Zone 1 and the Doubled Zone will be Zone 9.

The first detector on Zone 2 will be Zone 2 and the Doubled Zone will be Zone 10. E.g Zone number + 8 = Zone number for Doubled Zone.

The Zone triggered will be identified through the resistor value by the system.

Radio Zone Expander

One GardTec Radio Zone Expander may be fitted directly to the RS485 Bus connections on the control panel PCB without the need for any interface card. A Radio Expander card will allow eight wireless zones & eight wireless Fobs.

Radio Zone Programming

When programming Radio Zones the zone numbering for the Radio Zones will start at 91.

When programming Radio Fobs the numbering of the Fobs will start at 81.

Fig.7

RADIO EXPANDER WIRING & SWITCH SETTINGS

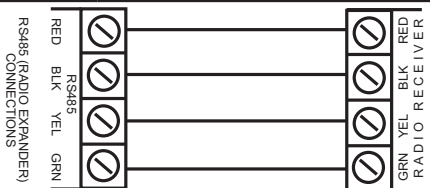

1ST RECEIVER
DIP SWITCH
SETTINGS

Initial Power Up

When the Control Panel is powered up it will be either set or unset dependent on the state of the Control Panel when it was powered down. The factory default state will be unset.

Reset to Default Modes

Note: It is ***ESSENTIAL*** that a 4 6 Yes No reset is done to all new systems before commencement of programming.

The Control Panel is now back to factory defaults.

If you intend to program the control panel via Gardtec Remote you should default the panel using **5 5 YES NO**. This will default the control panel and set-up all the remote comms options.

Two other reset modes are also available:

3 7 YES NO defaults the system and codes but leaves user names and zone descriptors intact.

1 9 YES NO defaults the Master User to **5678** and Engineer to **1234**

Note: If the engineer code has been 'Locked' into the system resetting to default modes will have no effect on the engineer code. The only way to release this state is to return the PCB to the factory (please note this is a chargeable service).

System Programming

The system may be programmed by the engineer by use of the engineer code (**1234** factory default). Other Engineer/User functions are also available to the engineer, these are as follows.

Set	Unset	Remove
Test	Log	Chime

Note: Details of the above functions are given in the User Manual.

Program Engineer Code

Programming of the Engineer Code is only possible via the Engineer Code (e.g **1234**). See Engineer Programming.

Engineer Programming Mode

Engineer Programming

To enter the engineer programming mode follow the steps outlined below:-

1. Remove all power from the system for at least 10 seconds.
2. Apply mains power to the control panel. The display will show, for example:-
3. Whilst this display is showing (the first five seconds) press for the reset required.
(E.g 4 6 Yes No).

The display will then show:-
This may show for several minutes.

The display will then show:-
The display may differ from the sample shown.

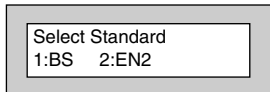
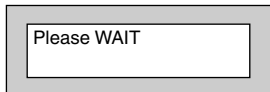
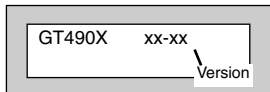

Selecting 1:BS - Panel may be programmed to comply with the old BS4737 Standards. DD243 requirements will still apply.

Selecting 2:EN2 - Panel may be programmed to comply with EN50131-1 for Grade 2 Systems. BS8243 requirements will still apply.

4. Select **2:EN2**.

Note: This document assumes that **2:EN2** has been selected. If **1:BS** has been chosen, please refer to GT490X Control Eng. Ref. Guide for further information. Available from the GardTec web site.

The display will show:-
This may show for several minutes.

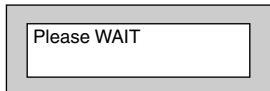

The display will then show:-

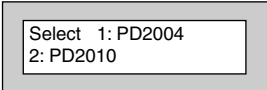

Select 1: PD2004
2: PD2010

5. Select either **1** or **2** depending on which standard you require.

The display will show:-

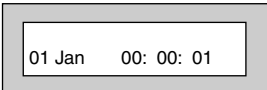

01 Jan 00: 00: 01

6. Enter Engineer code.
(1234 default). The display will show:-

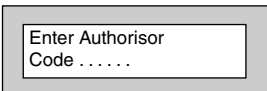

Enter Authorisor
Code

7. Enter the Authorisor code. The Authorisor code is the Master User, **(default 5678)**.
The display will show:-

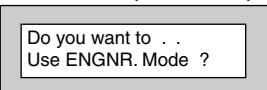

Do you want to . .
Use ENGR. Mode ?

8. Press Yes. The display will show:-

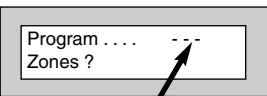

Program
Zones ?

A Header is indicated by three
underscores on the display.

From this point the panel is Engineer Mode and all Tamperers will be disabled.

Note: At any point when three underscores are shown on the display you are viewing a Header. You may move to the next Header by Pressing the NO Key or access the functions under the Header by pressing the YES Key.

You are able to jump to various common options when programming by entering the relevant menu numbers. With a Header showing, key in the appropriate menu number, then press Yes.

Note: Throughout the programming routine you may use the 0 (zero) Key to escape back one level. This does not apply when a numeric entry is expected, in this case complete the input before using the 0 Key to escape.

Factory Default Codes:

Engineer **BS / EN2 - 1234**

User 1 (Master) **BS/EN2 - 5678**

Available Headers & Options

Below is shown some of the Headers (menu numbers, see page 14) that are available and the options that appear under each Header. *Please refer to the GT490X Engineer's Reference Guide for further details. The manual is available from the web site.*

Program Zones...

- Zone Types
- Zone Descriptors
- Zone Wiring
- Zone Attributes
(Test/Part/Chime/Cleaner/Walk)
- Zone Double Knock, Arm, Log
- Zone E/E Mode
- Zone Event Tags

Program Setting Modes...

- Setting for Full Set
- Setting for Part 1 Set
- Setting for Part 2 Set
- Setting for Part 3 Set
- Setting Delay
- Setting Sounders
- Setting Confirmation
- Setting for Auto-Part Set

Program Entry Times...

- Entry Time 1
- Entry Time 2

Program Bells & Sounders...

- Bell Type & NovActive On/Off
- Bell Delay Number of Arms
- Bell & Sounder Ring
- Bell Tamper Mode
- Bell in Part Set

Program Keypad...

- Keypad Alert 1 Keys
- Keypad Alert 2 Keys
- Quick Key
- Keypad Number of Keypads
- Keypad Backlight Mode
- Ace/Prox

Program Digicom...

- Digicom Type or Test
- Vo-Comm
- Digicom Delay / Part
- Digicom Channels

Digicom Functions

- Digicom View Modem Log
- Modem Functions
- Comms Functions
- Comms Off
- Site ID
- Tel No. 1
- Tell No. 2
- Line Monitor
- Line Security
- Restore Reports
- Open / Close Channels
- Advanced Functions

Modem Functions

- Modem Comms Off/On
- Modem Mode
- Double Ring
- Keypad Lock / In-Use Text
- Site ID Code
- Password
- Tel No. 1
- Tel No. 2
- Modem Access
- Send Keys / Status

Program Linefault Modes...

- Linefault Sounders
- Linefault In Exit Mode
- Linefault Log Mode
- Line Fault Detect Time

Panic / Duress

PA Mode / Bells Only / Bells Always
Silent Always / Bells if Line Fault
Testable / Non-Testable
PA Confirm (*PA Confirm is defaulted to Off*).
Off/8Hr/10Hr/12Hr/14Hr/16Hr/18Hr/20Hr.
Duress Off (*To conform with EN standards, Duress is defaulted to Off and cannot be changed*)

Program PGM 2 / 3 / Timers...

PGM2/3 Operating Mode
PGM2 Mode
PGM3 Mode
Timer 1 On Time
Timer 1 Off Time

Program Reset / Mains...

Mains Fail Delay
Alarm Reset
Tamper Reset
Fault Reset
Alarm Restore On/Off
Abort Time

Program Sounder Levels...

Chime Level
Entry / Exit Level
Key Beep Level

Program PGM1

PGM 1 O/P
Custom Output 1- 8

Program Engineer Code...

Code
Lock / Unlock

Program Service...

Mains OK 50Hz
Save Panel NVM to PTM
Load Panel NVM to PTM
Service Timer
Time To Next Service
Service Tel No.
Lock-Out On/Off
Engineer Mode Constant/Timed

Program Custom Screens...

LCD Status Display
(To conform with EN standards, LCD Status is defaulted to Off and cannot be changed).
LED Status Display
Custom Display On / Off
Program Custom Text

Program Diagnostics / Log...

List Event Log
Change List Diagnostics
PSU Diagnostics
NovActive Diagnostics
PSU Test Time
Change / List Test Limits
Aux Volts
Battery Volts On Charge
Battery Volts Off Charge

Program Alarm Confirm...

Confirm Window Time
Confirm On Entry
Confirm Sounder Mode
Confirm Reset Mode
Confirm Secondary Time
Confirm ET Mode
Confirm Bell Mode
Confirm Strobe Mode
Confirm Start Delay
Confirm Comms Restore
Confirm Keypad Opening
Confirm ACE Battery Monitor

Common Options With Menu Numbers

You are able to jump to various common options when programming by entering the relevant menu numbers. With a Header showing, key in the appropriate menu number, then press Yes.

For a full list of Common Options please refer to the GT490X Engineer's Reference Guide which is available on the web site.

Menu	Item
12	Full Set Setting Time / Setting Mode
22	No. of Keypads / Multi On Off / K/Switch
28	Entry Time 1
34	Digicom Type
38	Engineer Code
46	Main Fail Delay
47	Tamper / Fault Reset Mode
50	Zone Response
52	Zone (Attributes)
155	Confirm Time Window (BS8243 Section)
139	PSU Test Time

Note: If any Zones (panel or expander zones) are not used the terminals for that Zone should be left open (no link) and the Zone should be programmed as Off

Fig.8

Resistor Colour Codes

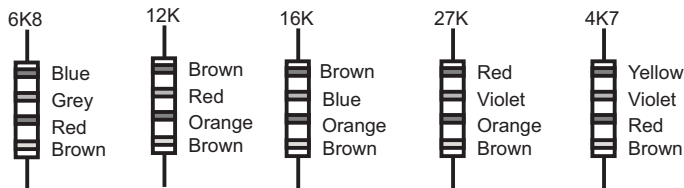

Programming Alarm Confirm

This section is used to program options that are relevant to BS8243. Before programming these options please take time to read the following notes that will help in your understanding of BS8243

All communications systems that require a Police URN will need to conform to BS8243.

These notes intended as a guide only and should be read in conjunction with the relevant standards relating to the alarm system giving particular attention to EN50131-1 and BS8243. These may be obtained from the British Standards Institute.

BS8243 options available are.

Confirm Time Window (default = 60)

This time window may be programmed between 1 and 120 minutes. To comply the required time should be between 30 and 60 minutes.

Confirm on Entry (default = On)

This option may be programmed to On or Off. If Confirm on Entry = Off then confirmed alarms to central station are disabled if the entry timer is started. If ACE or G-Tag is used then it is permissible to set this option to On.

Sounder Mode (default = Unconfirmed)

This option controls the system speakers fitted, options are confirmed or unconfirmed.

If Sounder Trigger = Confirmed then internal sounder will only trigger with a confirmed alarm.

If Sounder Trigger = Unconfirmed then internal sounders will trigger with unconfirmed alarms.

This feature is not mandatory for BS8243

Reset Mode (default = Any)

Choose from Any or Normal.

If Unconfirm = Any then any code can be used to reset an un-confirmed alarm.

If Unconfirm = Normal then the programmed reset mode for alarm will still be required i.e. if alarm reset has been programmed as engineer and Unconfirm reset is Normal then an engineer reset will be required for Un-confirmed alarms.

Confirm Secondary Time Window (default = 60 minutes)

This time window may be programmed between 1 and 120 minutes we would suggest a time between 30 and 60 minutes but should typically be the same time as the confirm time window. This option affects zones that have been allocated as secondary zones only. For functionality please refer to Secondary Zones Below.

Keypad Opening (default = Always On)

This controls the keypad option during Entry/Alarm, and controls whether the keypad will lock-out during entry or in an alarm condition. The option is used for BS8243 systems using G-Tag and the keypads need to lock-out in certain circumstances. Settings available are:

Always On	Keypads will always be accessible
Off in Entry	Keypads will be locked-out during Entry period
Off in Ent/Alm	Keypads will be locked-out during Entry period or during alarm
Default = Always On	

ET (Exit Terminator) Mode (default = Set)

If ET Mode = Set then the exit terminator zone will terminate the exit procedure.
If ET Mode = Door Lock and the ET zone (door lock) is operated on entry then all confirmed alarms will be disabled.

Bell Mode (default = Unconfirmed)

This option controls the bells fitted to the system, options are confirmed or un-confirmed.

If Bell Trigger = Confirmed then Bell will only trigger with a confirmed alarm.

If Bell Trigger = Unconfirmed then Bell will trigger with un-confirmed alarms.

This feature is not mandatory for BS8243

Strobe Mode (default = Unconfirmed)

This option controls the Strobe(s) fitted to the system, options are confirmed or un-confirmed.

If Strobe Trigger = Confirmed then Strobe will only trigger with a confirmed alarm.

If Strobe Trigger = Unconfirmed then Strobe will trigger with un-confirmed alarms.

This gives the ability to show to the keyholder from outside the premises that a previously unconfirmed alarm has is now confirmed.

This feature is not mandatory for BS8243

Confirmed Start Delay (default = 000m)

May be programmed between 0 & 120 minutes (default 0).

If programmed to anything other than 0 the panel cannot send confirmed signals until the time programmed has expired. This time starts when the system has set and will prevent confirmed alarms being generated in situations when a person has been accidentally locked in the building.

This feature is not mandatory for BS8243

Ace Low Battery (default = On)

Options are On or Off. This option allows for the use of new control panel boards with V5.1 or later software to be used with earlier keypads. If older non BS8243 compliant type keypads are used with V5.1 or later this option should be programmed to Off. It is a requirement of BS8243 that when using ACE Low Battery is reported to the end user if the system is set using ACE.

See BS8243 Portable ACE used for setting and unsetting.

Secondary Zones

The Program Part / Test /Chime option has now been renamed to Program Zone Attributes. Within this section you are able to allocate zones as Secondary Zones. Secondary type zones would be used for detectors that may be deemed as having an over sensitive nature, this will stop unwanted user call-outs. Zones that are entered as Secondary will follow the chain of events below.

During a set period triggering a Secondary Zone will start the Secondary Time Window. This will be logged but no further action is taken. If the second zone to alarm during the same set period is also a Secondary Zone then it will be logged and the Secondary Time Window will be restarted.

If the time set within the Secondary Time Window is still running and a zone that is not allocated as a Secondary Zone is triggered the event will be logged an Alarm A (unconfirmed) and Alarm B (confirmed) will be transmitted.

This feature is not mandatory for BS8243.

Comms Restore

With Comms Restore turned on any outstanding alarm channels will be restored at the end of the Confirm Time Window.

This feature is mandatory for BS8243

Perimeter Zones

Within the Program Zone Attribute section you are able to allocate zones as Perimeter. Zones that are entered as Perimeter will follow the chain of events below.

When activated an unconfirmed alarm will be transmitted to the central station. An output or digi channel may be programmed as perimeter (or if using Point ID a new signal type of perimeter will be sent). This will allow central station to inform the keyholder that an unconfirmed alarm has been received and is a perimeter type device i.e window backdoor etc. etc. This feature is not mandatory for BS8243.

Scenarios Relating to BS8243.

Sounder / Bell Considerations

Please note careful consideration should be given when programming Confirm Sounder and Confirm Bell Modes. If both are programmed for confirmed and any of the above scenarios occur no local sounders will activate.

Other BS8243 Notes to Consider

When a system auto re-arms with a zone in fault condition The GardTec control panel will omit the zone concerned. A signal should be sent to the central station indicating that a detector(s) has (have) been isolated. To achieve this a Digi channel should be programmed as Zone Exclude, this will automatically send the required signal as the detector is omitted.

Output Option (Status)

This option has three operating modes and is intended to provide a visual indication of the system status.

System Set	Output On for 10 seconds
System Unset	Output On for 1s Output Off for 1s for a 10 second period
Confirmed Alarm	Output On for 3 seconds Output Off for 1s until system reset.

It is envisaged that this status output would be fitted to an indicator (i.e. LED) that can be seen from outside the premises.

Typical Wiring Modes

Where Anti-Mask detectors are used, one of the below wiring modes may be utilised.

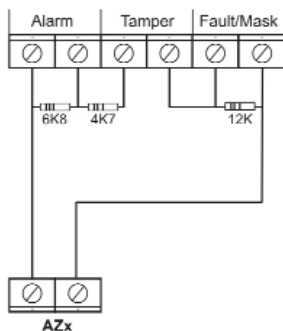

ELF1 wiring is used for detectors that have a relay output (a pair of terminals) for Fault or Mask.

The installer should check what output type the detectors are, noting that all detectors should be of the same type with regards to the Fault / Mask output.

Fig.9

Typical ELF1 (End of Line Format 1) Wiring.

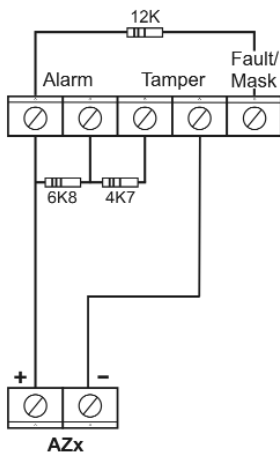

ELF2 wiring is used for detectors that have a transistor output (a single terminal) for Fault or Mask.

Note: For ELF2 wiring format the 12K resistor must be linked to the positive side of the zone terminals.

Fig.10

Typical ELF2 (End of Line Format 2) Wiring.

PD6662:2010 Update - new features

EN50131-1 2006 and BS8243

PD 6662, the document describing how the European standards for Intrusion and Hold-up Alarm systems (I&HAS) should be applied in the UK, has been completely revised. The revision takes into account the publication of a number of new, revised or amended European standards. It also adds some new standards and documents published by British Standards that add or vary requirements for alarm confirmation, commissioning and maintenance and false alarm management.

PD 6662: 2010 will replace the 2004 version when it is published but for a two year period (ending May 31st 2012) systems may be installed under either the 2004 or 2010 version of PD 6662.

The most significant changes are listed below.

Engineer Access.

Can now be turned off if the customer has agreed, (in writing). When entering the engineer menu, the panel will generate an audible sound for approximately 8 seconds to indicate that the engineer is on site, (grades 1, 2, and 3). For grades 2/3 the ATS must also send an engineer on site signal.

Confirmed PA

Confirmed PA has been added to the Control Panel menu. (Programming Panic / Panic). Please note that Confirmed PA can only be produced by activating two zones programmed as panic or a keypad panic and a Panic zone.

If Mod + FF is used, the Alarm B channel will be transmitted for PA/Intruder confirmation.

If Mod + PID is used the confirmed PA will transmit E129.

If Mod + SIA is used the confirmed PA will transmit HV.

Note: This would normally be used on systems that have lost police response for Panic.

Keypad disabled for 90 seconds.

The keypad will monitor the number of attempts without a valid User Code being entered. More than seven attempts will cause a keypad tamper and lock-out the keypad for 90 seconds. This will be displayed as 'LOCK-OUT Check' and will require a valid User Code entry to stop the sounders (only after 90 seconds). If the system was Unset only the internal sounders will operate. If the system was Set a full alarm will be generated.

Setting by digital key

Setting the system must be initiated from within the premises; when using a radio fob interaction with the keypad will be required.

Setting the system with a Gtag fob must be from a keypad (not from a remote setting point) to comply with the standards for monitored alarms.

Zones on soak test.

Zones that are put on test must be indicated to the user. When setting the system the user must acknowledge this by pressing No.

Entry Procedure

As per BS8243 - 2010, Annex G.

A confirmed alarm may now be generated on entry by straying off from the entry route into a normal alarm zone.

Engineer on site channel.

BS-EN50131 - 3 2006 plus A1 2009, as per 8.3.1.

When an Engineer code is entered a signal is sent to the ARC indicating an engineer is on site.

New Fast format channels.

Engineer on site. PA Confirm

New Contact ID and SIA triggers.

Engineer on site = Off/On.

New option for the reset modes.

Fault Reset = +Anti / Eng code / Anti code.



Creating Security Solutions.
With Care.

GT490X